

PLATEAU AMOVIBLE 1U P:720 / D=600 / D=800 mm



FEATURES

4 fixing points fit at the sides or rear and front 19" mounting angles Suitable with INFORM 19" profiles
Vented

COMPLIANCES

UL and cUL

Load Carrying Capacity: 25 kg

Surface Treatment : Fosfat coating

Painting : Ral7035 / Ral9005

STANDARDS

*ISO 9001:2000

*TSE:EN 61587-1 Mechanical Structures For Electronic Equipment - Tests For IEC 60917 And IEC 60297

*Climatic and Environment:EN 61587-1/4.2,IEC60068-2-1 ,

IEC60068-2-2 , IEC60068-2-30,

*Static Mechanical Load Lifting:EN61587-1/5.2.1

*Static Mechanical Load Stiffness:EN61587-1/5.2.2

*Dynamic Mechanical Load Vibration and Shock , Impact: EN61587-1/5.3.1,EN61587-1/5.3.3,IEC60068-2-6, IEC60068-2-27,

*Earth Bond:EN61587-1/6.2

*Flammability:EN61587-1/6.3

Material Definition and Properties , Thicknesses and Shipment Configuration

Part Definition	Material thickness	Material definition & properties	Shipment Configuration
Sliding Shelf	1,20 mm	DIN EN 10130 - 99 EREGLI DC-01 6112 CRS	1ea.
C-rail	1,50 mm	DIN EN 10130 - 99 EREGLI DC-01 6112 CRS	2ea.

PLATEAU AMOVIBLE 1U P:380



Front View

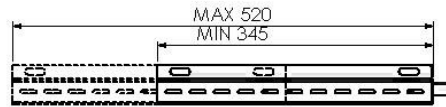

Side View

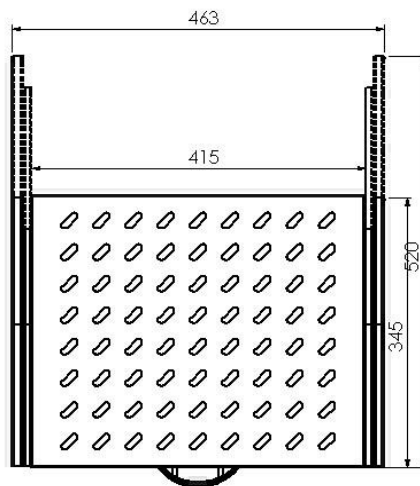

Top View

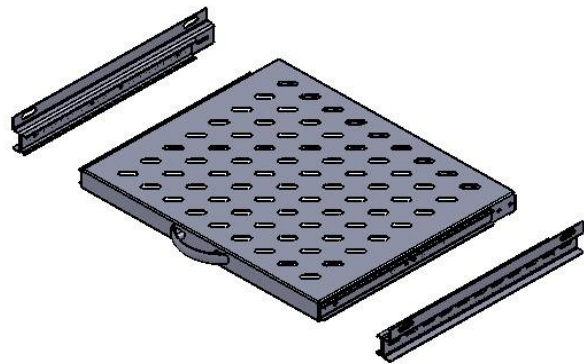

Explode View

Sliding Shelves

MODEL NAME	Product Definition	Dimensions (wxdxh) mm
RAP-PL-A-380-1-B	Sliding shelf vented enclosure depth=600 mm	465x345x30

Shipping Data

MODEL NAME	quantity	Shipping Dimension (palette) WxHxD	Net Weight (kg)	Gross Weight (kg)
RAP-PL-A-380-1-B	7	545x425x400	18,830	19,500

PLATEAU AMOVIBLE 1U P:520

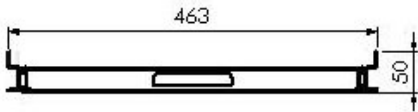

Front View

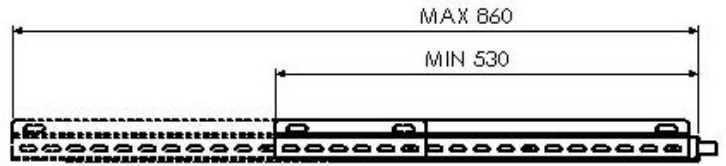

Side View

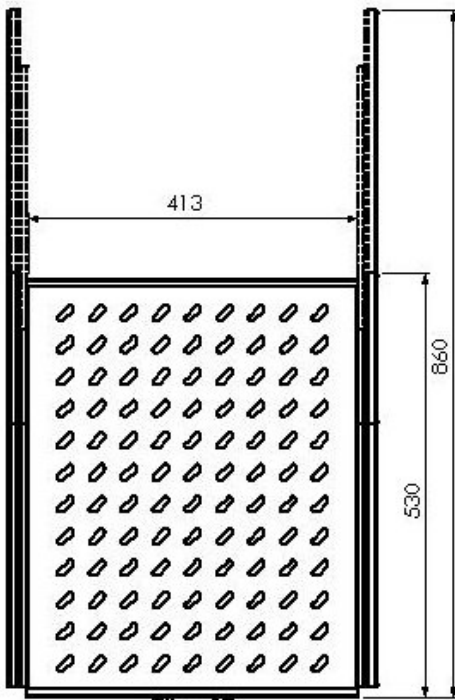

Top View

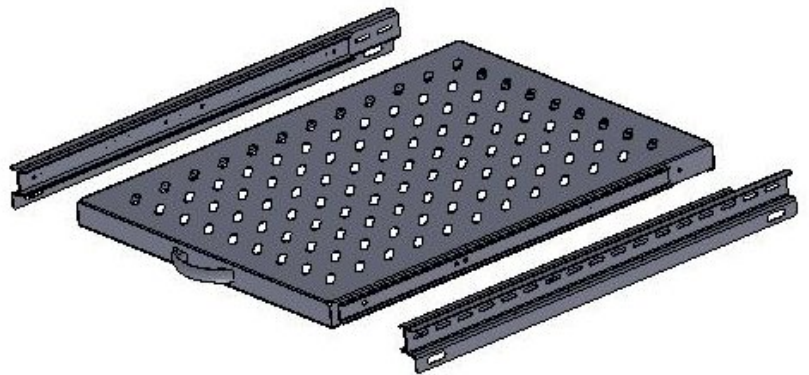

Explode View

Sliding Shelves

MODEL NAME	Product Definition	Dimensions (wxdxh) mm
RAP-PL-A-520-1-B	Sliding shelf vented enclosure depth=600 mm	465x345x30

Shipping Data

MODEL NAME	quantity	Shipping Dimension (palette) WxHxD	Net Weight (kg)	Gross Weight (kg)
RAP-PL-A-520-1-B	7	540x440x610	27,860	29,000